

FAN-CLUB

BAUANLEITUNG

Nr. 15

ZUM SAMMELN



CLUBMODELL: Fan Club Modell „Schwerlast Truck“

Diesmal haben wir für Euch den „Schwerlast-Truck“ entwickelt. Dieses Modell besteht aus den Baukästen „Cars & Trucks“ (Art.-Nr. 34950) sowie „King of the Road“ (Art.-Nr. 30201). Ausser diesen Baukästen sind keine weiteren Teile notwendig. Wie Ihr in der Abbildung seht, eignet sich dieser „Schwerlast-Truck“ auch super zum Transport unseres neuen „Helicopter“ (Art.-Nr. 34989).

Sehr viel Spass macht dieser Truck, wenn er mit Motoren und Fernsteuerung ausgestattet wird. Zum Fahrtrieb empfehlen wir das neue „Power Motor Set“ (Art.-Nr. 34965), denn nur mit dem kräftigen Power Motor „geht die Post ab“. Zum Lenken eignet sich der bekannte S-Motor aus dem „Mini Motor Set“ (Art.-Nr. 30342), und zum Fernsteuern bzw. zum Ansteuern der Motoren natürlich unser „IR Control Set“ (Art.-Nr.: 30344).

Und als ideale Stromversorgung gibt's nun den passenden fischertechnik Akku-Pack aus dem neuen „Accu Set“ (Art.-Nr. 34969). Wie sich die Motoren, der Empfänger und der Akku-Pack in den „Schwerlast-Truck“ einbauen lassen, ist in der Bauanleitung des Baukastens „Cars & Trucks“ (Art.-Nr. 34950) ab Seite 16 beschrieben.













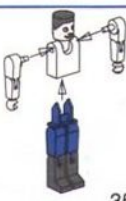









































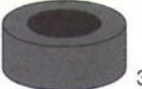





























Darüber hinaus könnt Ihr den Schwertransporter mit Blinklichtern und Scheinwerfern ausstatten. Dafür empfehlen wir das neue „Lights-Set“ (Art.-Nr. 34970) mit seiner Elektronik für Dauer- und Blinklicht.

Wir wünschen Euch viel Spass beim Bauen!

fischertechnik®



Einzelteilübersicht

 31010	8x	 31892	2x	 32855	2x	 35806	2x	 37679	4x
 31011	1x	 31894	1x	 32859	8x		 38225	1x	
 31013	2x	 31915	1x	 32861	4x	 35998	2x	 38240	4x
 31060	16x	 31916	1x	 32869	1x	 36227	18x	 38241	10x
 31061	18x	 31918	2x	 32870	8x	 36334	3x	 38242	2x
 31081	1x	 31982	30x	 32879	18x	 36702	4x	 38245	6x
 31263	1x	 31983	8x	 32881	15x	 36703	8x	 38246	4x
 31264	1x	 31997	1x	 32882	4x	 36819	8x	 38249	1x
 31422	4x	 31998	1x	 32883	6x	 36912	2x	 38251	1x
 31426	4x	 31999	1x	 32913	10x	 36914	3x	 38260	1x
 31436	10x	 32064	13x	 35049	10x	 36921	2x	 38413	2x
 31597	4x	 32071	4x	 35050	4x	 36922	3x	 38423	8x
 31690	1x	 32321	2x	 35063	2x	 36950	3x	 38428	2x
 31766	2x	 32330	2x	 35065	8x	 37033	1x	 38446	2x
 31843	2x	 32627	4x	 35067	1x	 37237	38x	 38464	8x
 31848	2x	 32850	6x	 35073	2x	 37238	10x	 38472	1x
 31888	2x	 32852	1x	 35129	2x	 37468	7x		
 31891	2x	 32854	1x	 35414	6x	 37636	4x		

Schwerlast-Truck

10

Baustufen 1 - 9
siehe Cars & Trucks
S. 16 - 19

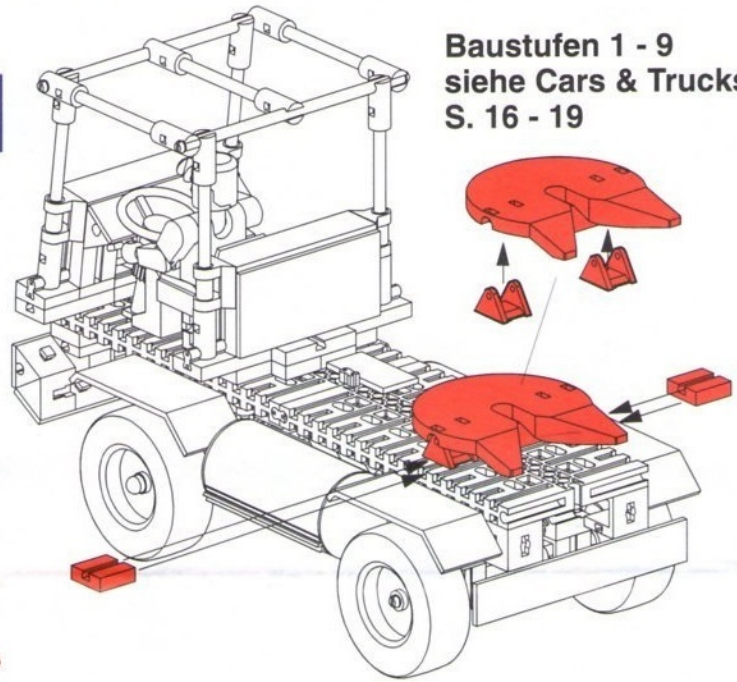

11

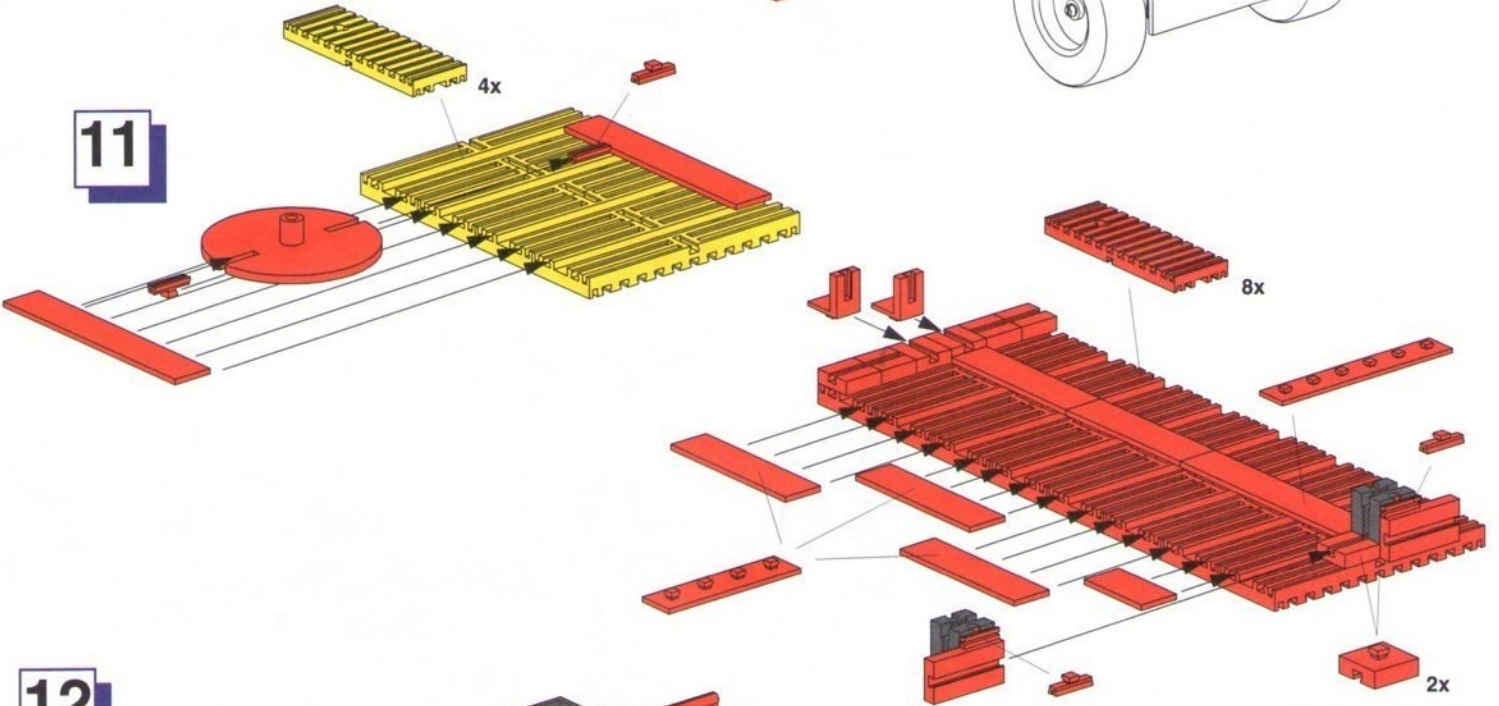

12

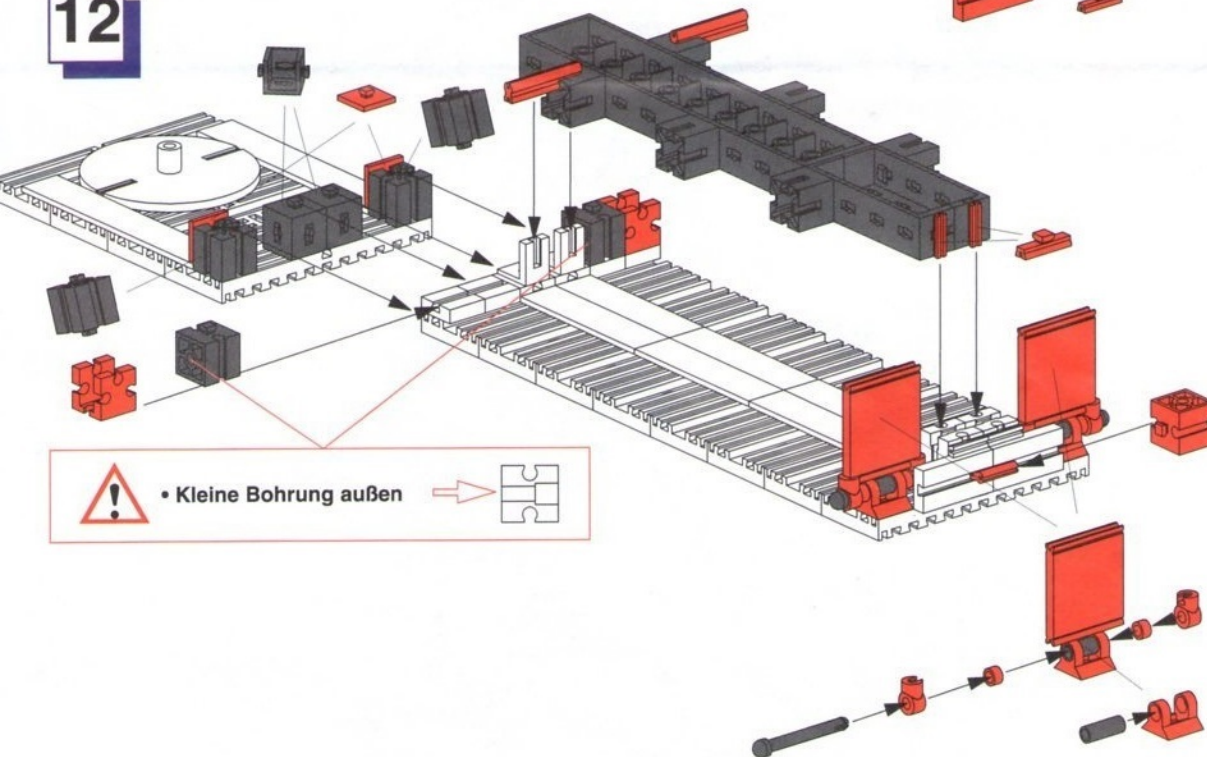

• Kleine Bohrung außen →



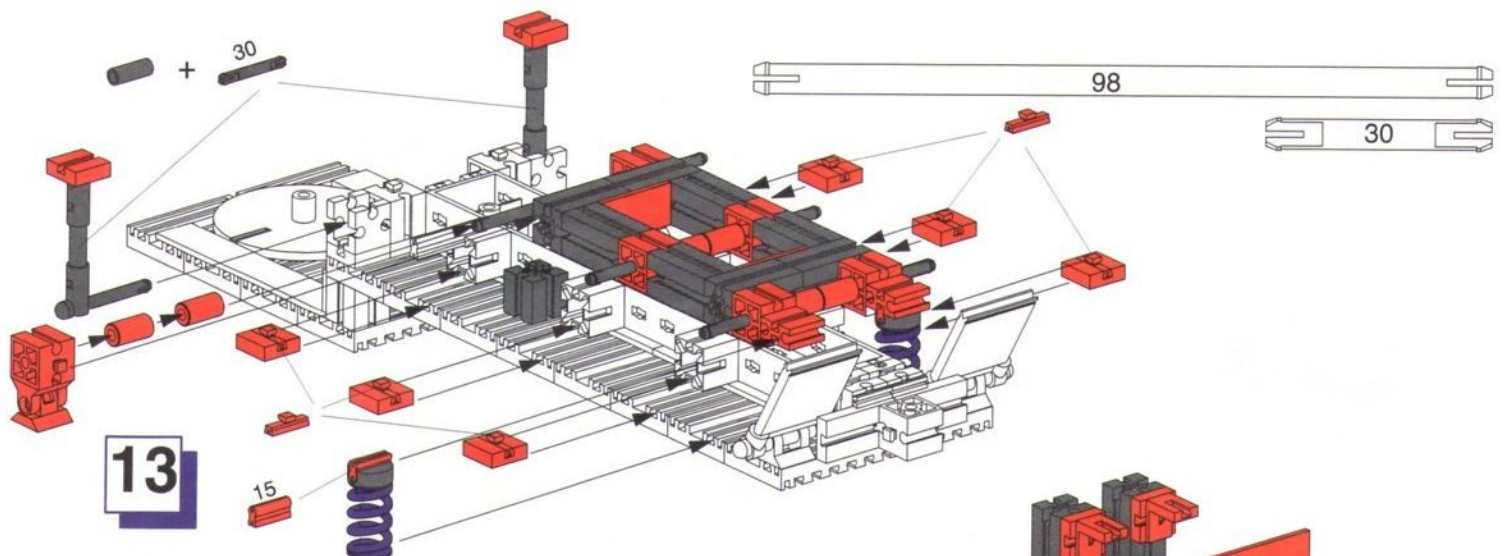

13

14

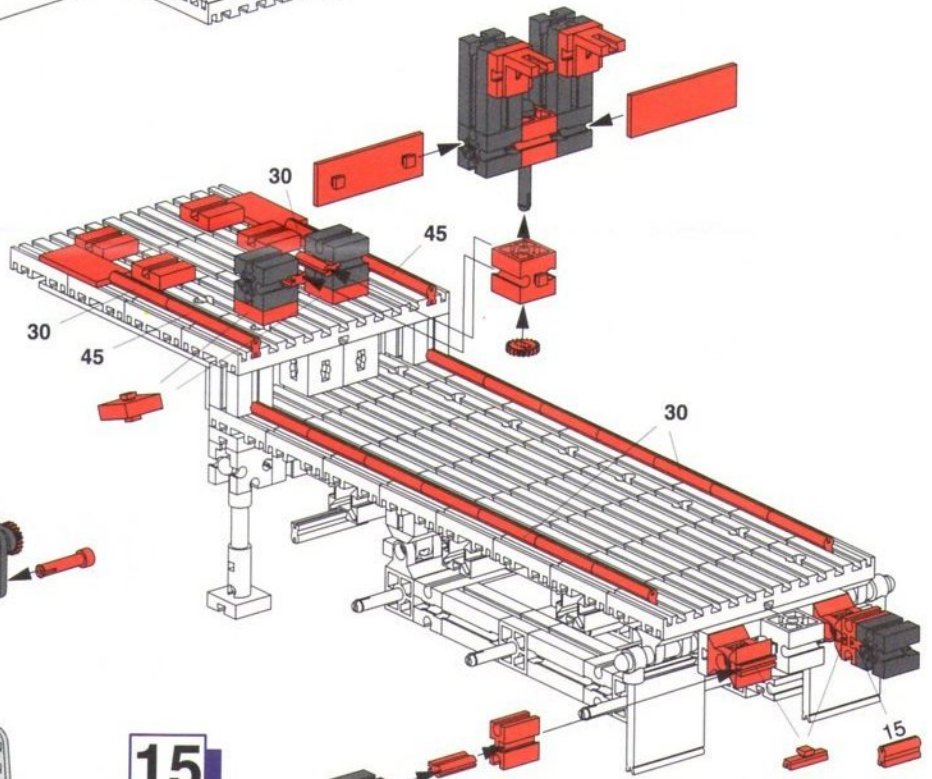

15

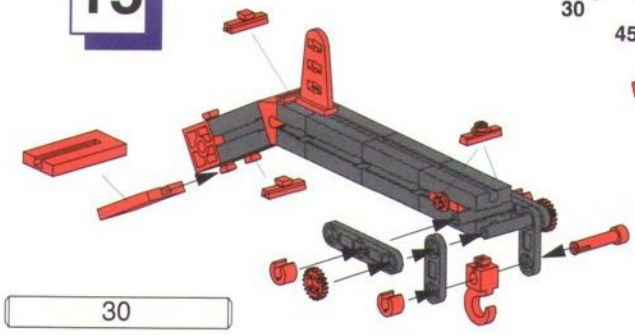

16

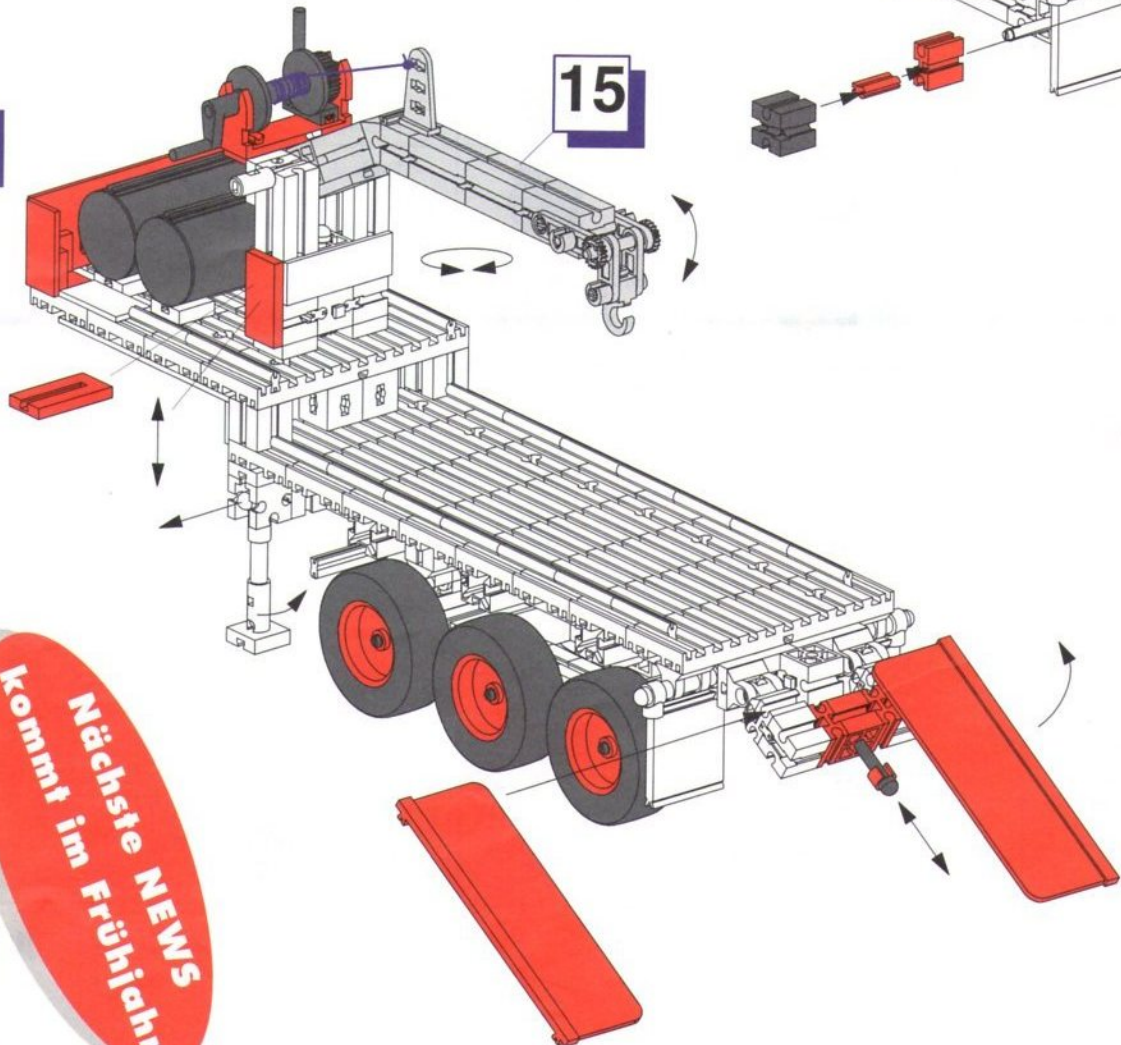

15

**Nächste NEWS
kommt im Frühjahr**

I M P R E S S U M
Zeitschrift des Fischertechnik
FAN-CLUBS,
Gedruckt auf Recycling Papier,